

# FLFE..L

# FLF..L

- Zone 1, 2, 21, 22
- With LED tubes
- Easy re-lamping
- Designed to last over time



*"Ex e" terminal board housing*

*4 Joule shock resistant borosilicate glass*

*Simplified maintenance*



*White painted reflector/frame*

*Ex d execution type FLF..L*



# FLFE...L, FLF...L series Lighting fixtures with LED tubes

Lighting fixtures for LED tubes FLFE...L (Ex de) and FLF...L (Ex d) series have two low copper content aluminium heads fitted with G13 lamp holder, a tempered borosilicate glass tube that is resistant to changes in heat and a white painted aluminium reflector. The 'Ex de' lighting fixture features an "Ex e" terminal board housing that allows entry to the lamp with a cable gland with an "Ex" seal (normal) as specified in installation standard (EN/IEC 60079.14). The entry to the 'Ex d' lighting fixtures must be through an Ex "barrier" cable gland (sealed) or, in the case of a conduit system, with an EYS, EZS series sealing fittings. The round cross section of the lamp provides a better "Cx" coefficient with less resistance to the wind and less accumulation of dust. For this reason, these units are recommended for use in hazardous places where climatic and environmental conditions are severe and as they require less maintenance thanks to a very high ageing index. As the electrical components are housed on a frame with guides, re-lamping is quick and efficient. The fact that the fixture is fitted with a glass tube as opposed to a plastic material, makes it more effective and with a longer lifespan.

## Application sectors:



Oil refineries



Chemical and petro-chemical plants



Oil and combustible liquid depots



Offshore plants



Onshore plants



Stair handrails



Farm produce applications



100% Cortem product

## CERTIFICATION DATA

|                                  |  |  |   |  |
|----------------------------------|--|--|---|--|
| <b>Classification:</b>           | Group II   | Category 2GD   |   |  |
| <b>Installation:</b> EN 60079.14 | zone 1 - zone 2 (Gas)  | zone 21 - zone 22 (Dust)   |   |  |
| <b>Marking:</b>                  | CE 0722 Ex II 2GD Ex db op is IIC T6 Gb - Ex tb op is IIIC T71÷T80°C Db IP66 (FLF)   |  |   |  |
|                                  | CE 0722 Ex II 2GD Ex db eb op is II C T6 Gb - Ex tb op is IIIC T71÷T80°C Db IP66 (FLFE)  |  |   |  |
| <b>Certification:</b>            | ATEX CESI 09 ATEX 008  |  |   |  |
|                                  | IECEX CES 11.0021  | All IEC Ex, INMETRO and TR CU certification data can be downloaded at <a href="http://www.cortemgroup.com">www.cortemgroup.com</a> |   |  |
|                                  | TR CU AVAILABLE  |  |   |  |
|                                  | INMETRO DNV 12.0159  |  |   |  |
| <b>Standards:</b>                | CENELEC EN 60079-0: 2018, EN 60079-1: 2014, EN 60079-7: 2015/A1: 2018, EN 60079-31: 2014 and EUROPEAN DIRECTIVE 2014/34/UE<br>IEC 60079-0:2004, IEC 60079-1:2007, IEC 60079-7:2006, IEC 61241-0:2004, IEC 61241-1:2004<br>European Directive 2004/108 Electromagnetic compatibility<br>European Directive 2012/19/UE, 2002/96/CE, 2003/108/CE WEEE<br>European Directive 2011/65/UE RoHS |  |   |  |
| <b>Class temperature:</b>        | 85°C (T6)  |  |   |  |
| <b>Ambient temperature:</b>      | Standard -20°C +55°C   | with emergency -20°C +50°C   | special with emergency -20°C +55°C (T5) |  |
| <b>Degree of protection:</b>     | IP66   |  |   |  |

## FLFE...L, FLF...L series Lighting fixtures with LED tubes



### MECHANICAL FEATURES

|                              |  |
|------------------------------|--|
| <b>Body:</b>                 | Low copper content aluminium alloy heads   |
| <b>External tube:</b>        | Shock and high temperature resistant borosilicate glass  |
| <b>Gaskets:</b>              | Acid/hydrocarbon resistant NBR on covers   |
| <b>Inner frame:</b>          | White painted aluminium that acts as reflector   |
| <b>Bolts and screws:</b>     | Stainless steel  |
| <b>Cap chain:</b>            | Stainless steel  |
| <b>Mounting:</b>             | 2 x M8 holes   |
| <b>Entries:</b>              | 2 x ISO M25 entries for FLFE, fixture kit with PLG2IB plug and NAV25IB cable gland<br>2 x 3/4" threaded NPT for FLF. Fixture set with 1 x PLG2NA plug            |
| <b>Coating:</b>              | Polyester coating Ral 7035 (Light grey)  |
| <b>Corrosion Resistance:</b> | The STANDARD of the aluminium alloy used by Cortem has passed the tests required by standards EN60068-2-30 (hot/humid cycles) and EN60068-2-11 (salt mist tests) |



ORIGINAL PRODUCT

### ELECTRICAL FEATURES

|                         |  |
|-------------------------|--|
| <b>Lamp holders:</b>    | Bi-pin G13   |
| <b>Rated voltage:</b>   | 220/240 V AC   |
| <b>Rated frequency:</b> | 50/60 Hz   |
| <b>LED tubes:</b>       | 11-22-31 W max.  |
| <b>Connection:</b>      | Direct to the terminal board L, N, Pe section 4 mm <sup>2</sup> with jumpers suitable for input/output |
| <b>Power factor:</b>    | 0,98   |
| <b>Emergency unit:</b>  | Electronic inverter 220V/240V, 50/60Hz. Batteries Ni/Cd, 4 Ah o 7 Ah, 6 V                              |
| <b>Wiring:</b>          | Silicone rubber cables with glass braid insulation for high temperatures                               |
| <b>Safety:</b>          | Internal safety switch installed for emergency lighting fixtures                                       |

*NOTE: The technical and electrical specifications may be changed without notice due to continuous developments of LED technology.*

### ACCESSORIES AVAILABLE / SPECIAL REQUESTS

Different rated voltages  
Installation mounting brackets  
Stainless steel or galvanized steel guard with external aluminium protection  
External aluminium protection recommended for outdoor installations  
Re-lamping bracket for use on in-line lighting fixtures  
Cable gland: NEVB2NB for armoured cable or NAVB2NB for non-armoured cable (only for FLF...L)  
Lighting fixture with separate emergency battery pack for temperatures of -20°C to +55°C (code FLFE-222EF7E)  
Cable entry: 2 x ISO M20 holes. Lighting fixture with 1 model PLG1IB plugs and 1 model NAV20SIB cable glands for non-armoured cable (code FLFE-111LEF4/20)

# FLFE...L, FLF...L series Lighting fixtures with LED tubes

## Ex de lighting fixtures

| Code      | Dimensions mm |      |     |     | LED tubes n° | Power supply | Lumen* | Watt* | Weight kg | mm           |
|-----------|---------------|------|-----|-----|--------------|--------------|--------|-------|-----------|--------------|
|           | A             | A1   | B   | C   |              |              |        |       |           |              |
| FLFE-111L | 725           | 640  | 142 | 197 | 1            | 220/240 Vac  | 925    | 11    | 5,0       | 240x230x800  |
| FLFE-211L | 725           | 640  | 142 | 197 | 2            | 220/240 Vac  | 1850   | 11    | 5,0       | 240x230x800  |
| FLFE-122L | 1325          | 1240 | 142 | 197 | 1            | 220/240 Vac  | 2150   | 22    | 7,8       | 240x230x1410 |
| FLFE-222L | 1325          | 1240 | 142 | 197 | 2            | 220/240 Vac  | 4300   | 22    | 7,8       | 240x230x1410 |
| FLFE-131L | 1625          | 1540 | 142 | 197 | 1            | 220/240 Vac  | 2700   | 31    | 9,5       | 240x230x1700 |
| FLFE-231L | 1625          | 1540 | 142 | 197 | 2            | 220/240 Vac  | 5400   | 31    | 9,5       | 240x230x1700 |

\* Indicative information depending on the installed tube

### DIMENSIONAL DRAWING

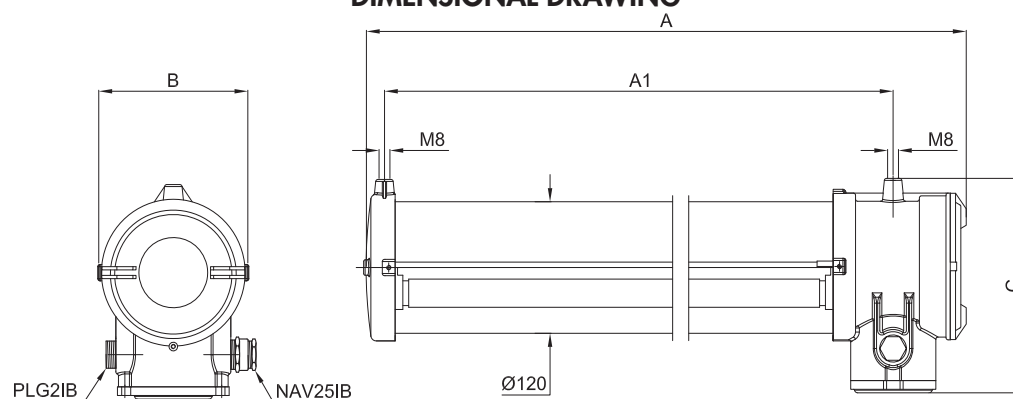

## Ex d lighting fixtures

| Code     | Dimensions mm |      |     |     | LED tubes n° | Power supply | Lumen* | Watt* | Weight kg | mm           |
|----------|---------------|------|-----|-----|--------------|--------------|--------|-------|-----------|--------------|
|          | A             | A1   | B   | C   |              |              |        |       |           |              |
| FLF-111L | 725           | 640  | 142 | 145 | 1            | 220/240 Vac  | 925    | 11    | 4,5       | 240x230x800  |
| FLF-211L | 725           | 640  | 142 | 145 | 2            | 220/240 Vac  | 1850   | 11    | 4,5       | 240x230x800  |
| FLF-122L | 1325          | 1240 | 142 | 145 | 1            | 220/240 Vac  | 2150   | 22    | 7,3       | 240x230x1410 |
| FLF-222L | 1325          | 1240 | 142 | 145 | 2            | 220/240 Vac  | 4300   | 22    | 7,3       | 240x230x1410 |
| FLF-131L | 1625          | 1540 | 142 | 145 | 1            | 220/240 Vac  | 2700   | 31    | 9,0       | 240x230x1700 |
| FLF-231L | 1625          | 1540 | 142 | 145 | 2            | 220/240 Vac  | 5400   | 31    | 9,0       | 240x230x1700 |

\* Indicative information depending on the installed tube

### DIMENSIONAL DRAWING

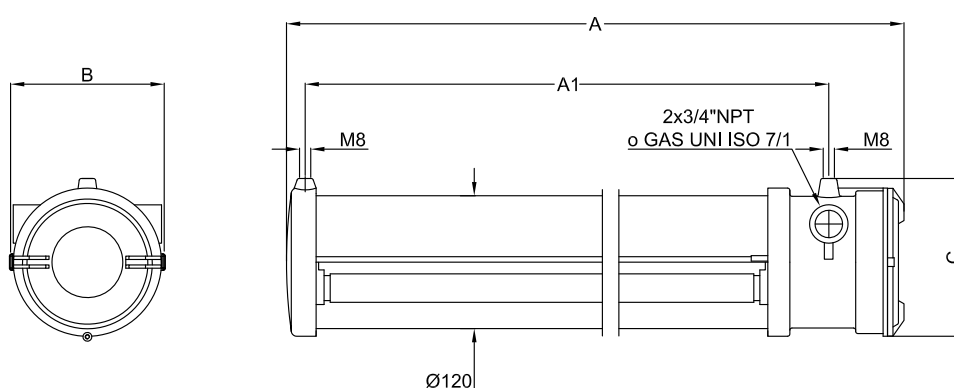

# FLFE...L, FLF...L series Lighting fixtures with LED tubes

## Lighting fixtures Ex de with emergency unit

| Code         | Dimension mm |      |     |     | Operating type   | N° of Lamp | Power supply | Lumen* (in emergency) | Watt* | Discharge time in minutes | Weight kg | mm           |
|--------------|--------------|------|-----|-----|------------------|------------|--------------|-----------------------|-------|---------------------------|-----------|--------------|
|              | A            | A1   | B   | C   |                  |            |              |                       |       |                           |           |              |
| FLFE-111LEF4 | 725          | 640  | 142 | 197 | normal+emergency | 1          | 220/240 Vac  | 946                   | 11    | 90                        | 5,0       | 240x230x800  |
| FLFE-211LEF4 | 725          | 640  | 142 | 197 | normal+emergency | 2          | 220/240 Vac  | 946                   | 11    | 90                        | 5,0       | 240x230x800  |
| FLFE-122LEF4 | 1325         | 1240 | 142 | 197 | normal+emergency | 1          | 220/240 Vac  | 1731                  | 22    | 40                        | 7,8       | 240x230x1410 |
| FLFE-222LEF4 | 1325         | 1240 | 142 | 197 | normal+emergency | 2          | 220/240 Vac  | 1731                  | 22    | 40                        | 7,8       | 240x230x1410 |
| FLFE-111LEE4 | 725          | 640  | 142 | 197 | only emergency   | 1          | 220/240 Vac  | 946                   | 11    | 90                        | 5,0       | 240x230x800  |
| FLFE-122LEE4 | 1325         | 1240 | 142 | 197 | only emergency   | 1          | 220/240 Vac  | 1731                  | 22    | 40                        | 7,8       | 240x230x1410 |
| FLFE-111LEF7 | 725          | 640  | 142 | 197 | normal+emergency | 1          | 220/240 Vac  | 960                   | 11    | 120                       | 5,0       | 240x230x800  |
| FLFE-211LEF7 | 725          | 640  | 142 | 197 | normal+emergency | 2          | 220/240 Vac  | 960                   | 11    | 120                       | 5,0       | 240x230x800  |
| FLFE-122LEF7 | 1325         | 1240 | 142 | 197 | normal+emergency | 1          | 220/240 Vac  | 1757                  | 22    | 60                        | 7,8       | 240x230x1410 |
| FLFE-222LEF7 | 1325         | 1240 | 142 | 197 | normal+emergency | 2          | 220/240 Vac  | 1757                  | 22    | 60                        | 7,8       | 240x230x1410 |
| FLFE-111LEE7 | 725          | 640  | 142 | 197 | only emergency   | 1          | 220/240 Vac  | 960                   | 11    | 120                       | 5,0       | 240x230x800  |
| FLFE-122LEE7 | 1325         | 1240 | 142 | 197 | only emergency   | 1          | 220/240 Vac  | 1757                  | 22    | 60                        | 7,8       | 240x230x1410 |

PHASE OUT

\* Indicative information depending on the installed tube

## DIMENSIONAL DRAWINGS

Dimensions in mm

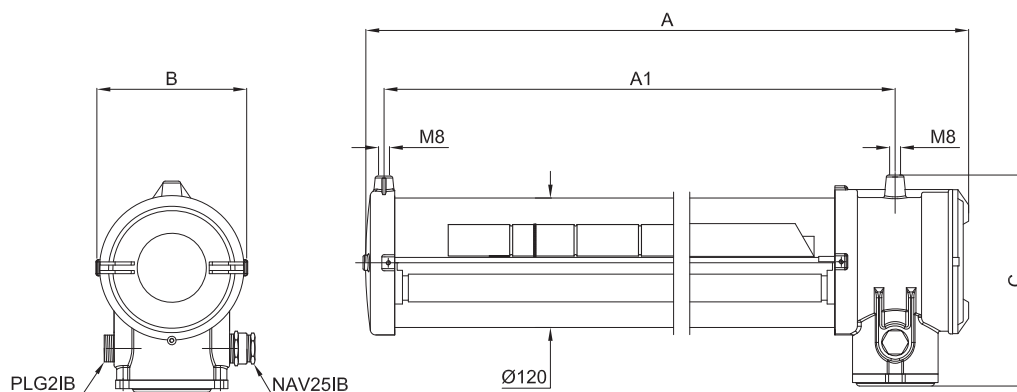

# FLFE...L, FLF...L series Lighting fixtures with LED tubes

## Lighting fixtures Ex d with emergency unit

| Codice      | Dimension mm |      |     |     | Operating type   | N° of Lamp | Power supply | Lumen* (in emergency) | Watt* | Discharge time in minutes | Weight kg | <br>mm |
|-------------|--------------|------|-----|-----|------------------|------------|--------------|-----------------------|-------|---------------------------|-----------|---|
|             | A            | A1   | B   | C   |                  |            |              |                       |       |                           |           |   |
| FLF-111LEF4 | 725          | 640  | 142 | 145 | normal+emergency | 1          | 220/240 Vac  | 946                   | 11    | 90                        | 5,0       | 240x230x800   |
| FLF-211LEF4 | 725          | 640  | 142 | 145 | normal+emergency | 2          | 220/240 Vac  | 946                   | 11    | 90                        | 5,0       | 240x230x800   |
| FLF-122LEF4 | 1325         | 1240 | 142 | 145 | normal+emergency | 1          | 220/240 Vac  | 1731                  | 22    | 40                        | 7,8       | 240x230x1410  |
| FLF-222LEF4 | 1325         | 1240 | 142 | 145 | normal+emergency | 2          | 220/240 Vac  | 1731                  | 22    | 40                        | 7,8       | 240x230x1410  |
| FLF-111LEE4 | 725          | 640  | 142 | 145 | only emergency   | 1          | 220/240 Vac  | 946                   | 11    | 90                        | 5,0       | 240x230x800   |
| FLF-122LEE4 | 1325         | 1240 | 142 | 145 | only emergency   | 1          | 220/240 Vac  | 1731                  | 22    | 40                        | 7,8       | 240x230x1410  |
| FLF-111LEF7 | 725          | 640  | 142 | 145 | normal+emergency | 1          | 220/240 Vac  | 960                   | 11    | 120                       | 5,0       | 240x230x800   |
| FLF-211LEF7 | 725          | 640  | 142 | 145 | normal+emergency | 2          | 220/240 Vac  | 960                   | 11    | 120                       | 5,0       | 240x230x800   |
| FLF-122LEF7 | 1325         | 1240 | 142 | 145 | normal+emergency | 1          | 220/240 Vac  | 1757                  | 22    | 60                        | 7,8       | 240x230x1410  |
| FLF-222LEF7 | 1325         | 1240 | 142 | 145 | normal+emergency | 2          | 220/240 Vac  | 1757                  | 22    | 60                        | 7,8       | 240x230x1410  |
| FLF-111LEE7 | 725          | 640  | 142 | 145 | only emergency   | 1          | 220/240 Vac  | 960                   | 11    | 120                       | 5,0       | 240x230x800   |
| FLF-122LEE7 | 1325         | 1240 | 142 | 145 | only emergency   | 1          | 220/240 Vac  | 1757                  | 22    | 60                        | 7,8       | 240x230x1410  |

PHASE OUT







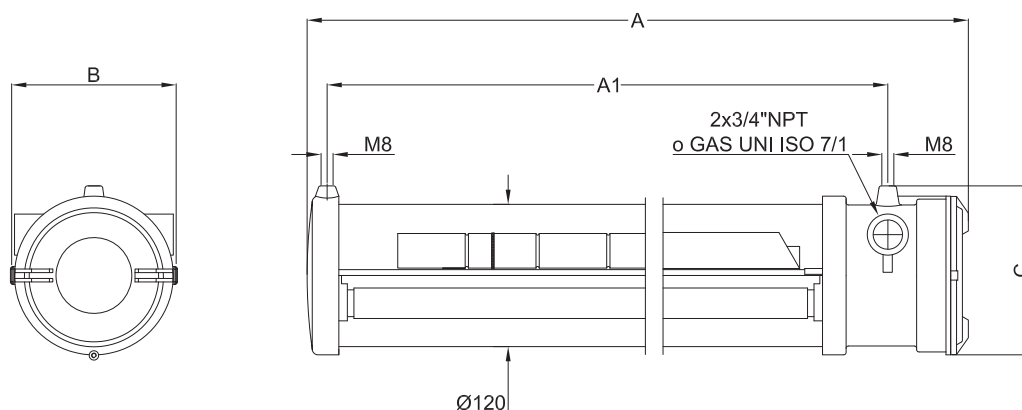











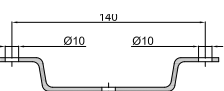

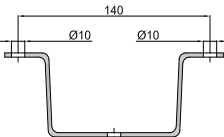

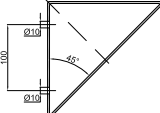

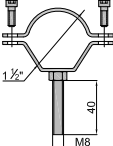

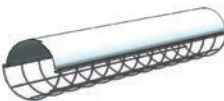







\* Indicative information depending on the installed tube

## DIMENSIONAL DRAWINGS

Dimensions in mm



## FLFE...L, FLF...L series Accessories and spare parts available

| ILLUSTRATION  | DESCRIPTION   | MODEL                               | FEATURES  | CODE                    | KEY   |
|---|---|-------------------------------------|---|-------------------------|---|
|    | LED tubes<br>G13 fitting  | 11 W Max.<br>22 W Max.<br>31 W Max. | Contact our Sales Office for availability   |                         |       |
|    | Tige  | Longitud:<br>250 mm                 | Material:<br>stainless steel  | BRF8MIN/250             |       |
|    | Type O eyebolt  |                                     | Material:<br>galvanised steel   | GOF-8                   |       |
|    | Type U bracket<br>complete with screws  |                                     | Material:<br>bracket: galvanised steel<br>screws: stainless steel                           | G-0609                  |       |
|    | Type V bracket<br>complete with screws  |                                     | Material:<br>bracket: galvanised steel<br>screws: stainless steel                           | G-0610                  |       |
|    | Type D bracket<br>complete with screws  |                                     | Material:<br>bracket: galvanised steel<br>screws: stainless steel                           | G-0611                  |       |
|   | Type P bracket  |                                     | Material:<br>galvanised steel   | G-0480                  |     |
|  | Guard with<br>Light blue/white<br>painted<br>10/10 aluminium<br>external protection | 11 W                                | Stainless steel guard   | G18-0529                |   |
|   |   | 22 W                                |   | G36-0529                |   |
|   |   | 31 W                                |   | G58-0529                |   |
|   |   | 11 W                                | Galvanised steel guard  | G18-0529G               |   |
|   |   | 22 W                                |   | G36-0529G               |   |
|   |   | 31 W                                |   | G58-0529G               |   |
|  | External protection   | 11 W                                | Light blue/white painted<br>10/10 aluminium<br>external protection                          | G18-568                 |   |
|   |   | 22 W                                |   | G36-568                 |   |
|   |   | 31 W                                |   | G58-568                 |   |
|   |   | 11 W                                | 10/10 stainless steel<br>AISI 304<br>external protection                                    | G18-568IN               |   |
|   |   | 22 W                                |   | G36-568IN               |   |
|   |   | 31 W                                |   | G58-568IN               |   |
|  | Cable gland   | FLF...L                             | For models and codes, visit<br><a href="http://www.cortemgroup.com">www.cortemgroup.com</a> | NAVB2NB<br>NEVB2NB      |   |
|  | Lamp holder   | FLF.-1..L                           | G13<br>250 V, 4 A   | STU3249-12/S            |    |
|   |   | FLF.-2..L                           |   |                         |   |
|  | Inverter  |                                     | 110/230 V<br>50/60 Hz   | 03240E205I/240          |    |
|  | Battery pack  |                                     | 4Ah 6V NiCd   | BATT4AH/D               |    |
|   |   |                                     | 7Ah 6V NiCd   | BATT7AH/D               |   |
|  | Re-lamping bracket<br>with clip system for<br>use on in-line lighting<br>fixtures   |                                     | Material:<br>galvanised steel   | G-0318<br>+<br>G-0318/1 |   |

# Installation and mounting methods and photometric diagrams

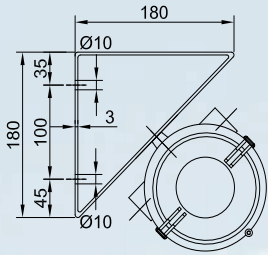

45° angle mounting  
TYPE "D"

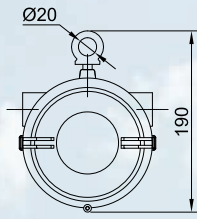

Pendant mounting with  
eyebolt TYPE "O"

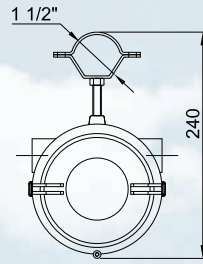

Mounting using 1.1/2"  
metal clamps TYPE "P"

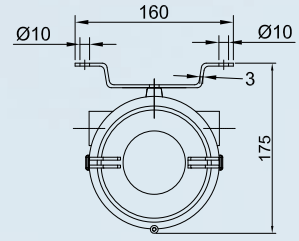

Low ceiling mounting with  
clamp TYPE "U"

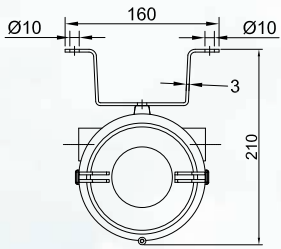

High ceiling mounting with  
clamp TYPE "V"

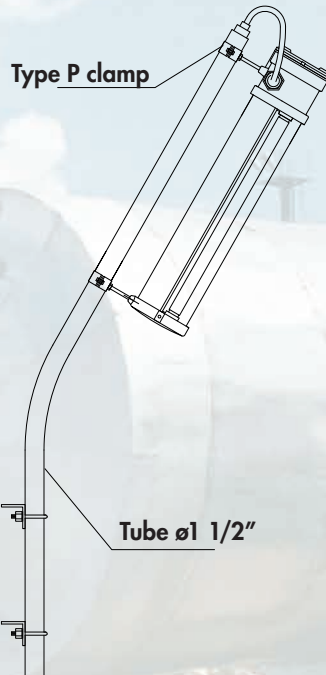

Pole mounting for FLF...L  
with barrier cable gland

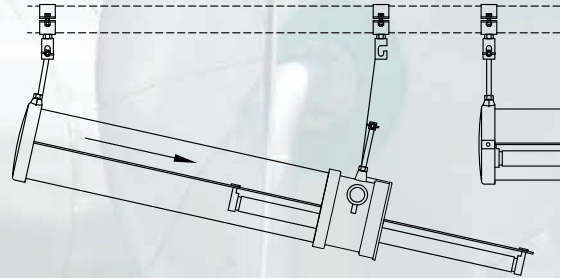
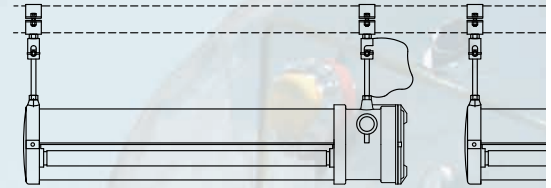

Mounting system with quick release clip for easy  
fluorescent tube replacement. System suitable for  
installing in-line lighting fixtures.

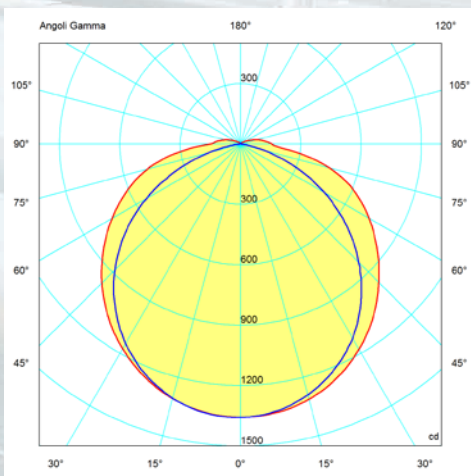

FLFE-222L / FLF-222L

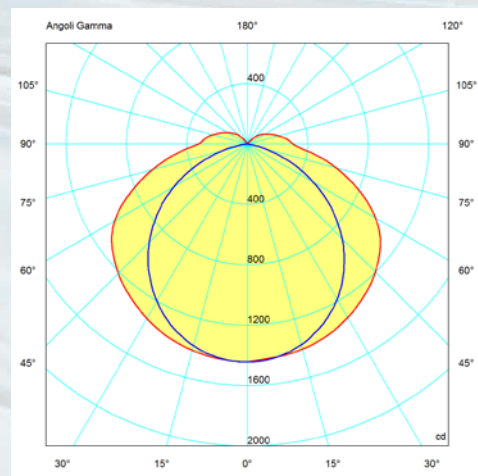

FLFE-231L / FLF-231L

On Cortem Group web site you can download .LDT and .IES lighting data files for the design and simulation of lighting levels in 2D and 3D, rendering and ray tracing.

— = plane 90270  
— = plane 0180